

# Project Linus Fringed Fleece Blanket

Providing Security Through Blankets

By Sandy Bovyn

© 2023 Project Linus National Headquarters. This pattern with its written instructions, photographs, and designs is intended for personal use and may be reproduced for that purpose only. Any other use, especially commercial use, is forbidden under law without express written permission from the copyright holder.

Use 1 piece of fleece—blanket and fringe are the same color/print. The preferred size is 1½ yds x 60". For a large teen use 2 yds x 60".

Begin by trimming off all selvages and clean it up by evening out all the edges. *It is easier to sew on a straight line than on a choppy one.*

1. Cut **TWO** 2" strips off long side of fleece.
2. Cut **TWO** 2" strips off the short side.

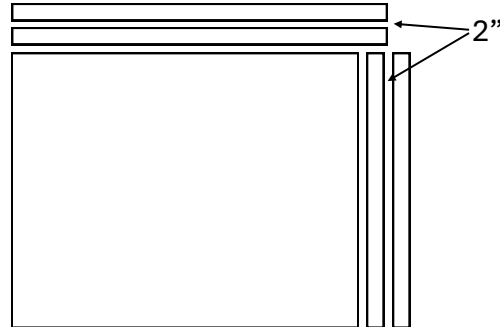

3. Now make a picture frame by laying the long 2" strips **on top** of the large rectangular piece of fleece across the long sides of the rectangle. Match up and pin in place as shown. The longest sides should be equal in length.

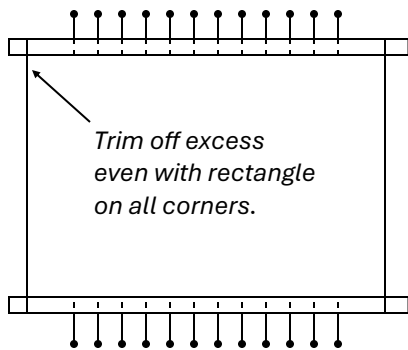

**Tip:** You can use a contrasting fleece fabric for the strips if you like. If your large rectangle is a print fleece, solid 2" strips make a nice accent color.

4. Next, place the last two strips **on top** of the short sides of the large fleece rectangle as shown, fitting the strips in between the long strips and pinning in place. Make sure both sides are equal in length before cutting to fit in between the outer pieces.

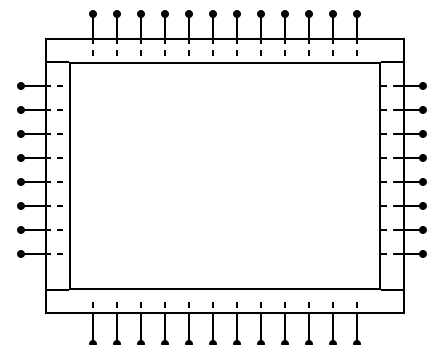
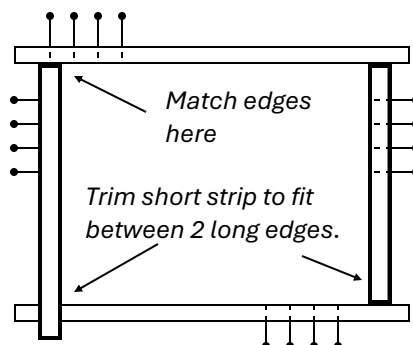

## 1½” Fringe

After following the instructions on Page 1, continue as follows:

5. Using a straight stitch and **walking foot**, sew a ½” frame from the inside edge, all around, attaching the 2” strips.

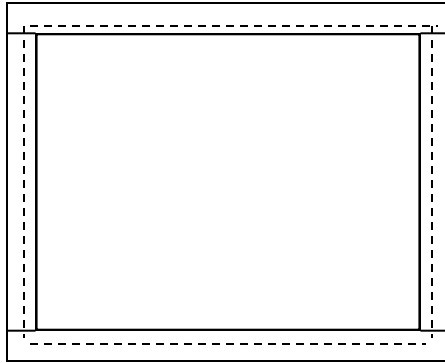

6. Using a zig zag stitch (Length 1.0; Width 3.5) go around all raw edges on the inside securing them to the back.

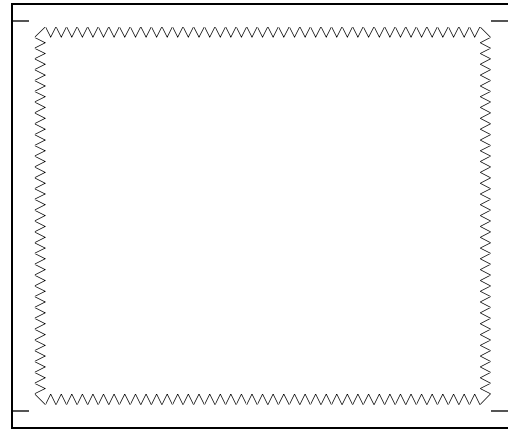
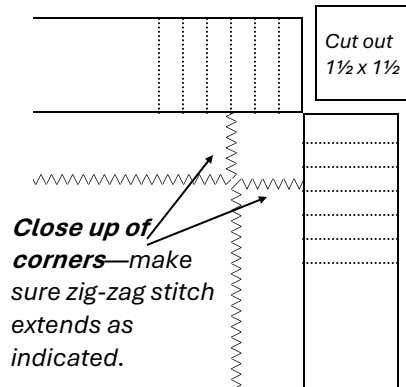

7. Cut small squares out of the 4 corners (1½” x 1½”)



8. Cut fringe ½” wide. You can cut the fringe with scissors or using a rotary cutter. A shape cut ruler really improves accuracy and helps to speed up the process.

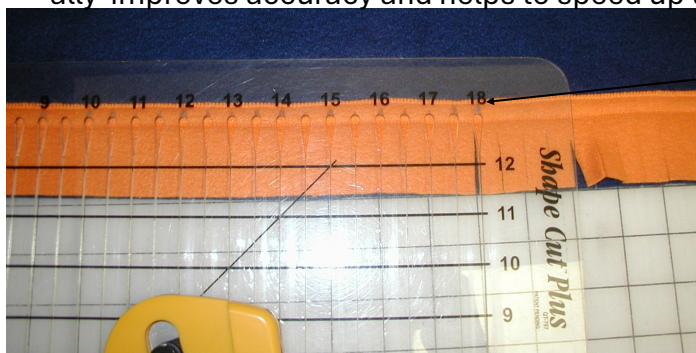

**Tip:** Turn your shape cut ruler so that the rounded (bulb) end of the slot is at the top. Then position the round “bulb” just above the stitching line. Insert your rotary cutter in the slot and cut until you are stopped by the top of the ruler. This way you won’t risk cutting through the stitching line and it goes very quickly once you get the hang of it!

# 1" Triple Fringe

After following the instructions on page 1 continue as follows:

- Using a straight stitch and walking foot, sew 1" from the outside edge, all the way around (dashed line).

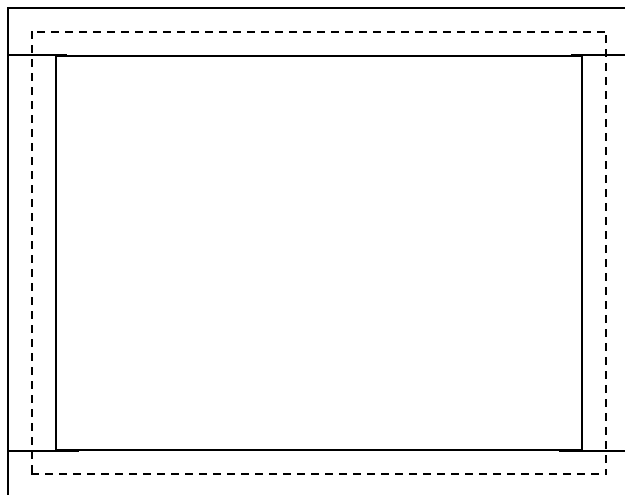

- On inside of long strips, clip one inch from the corner (red). (The other side is already clipped.)

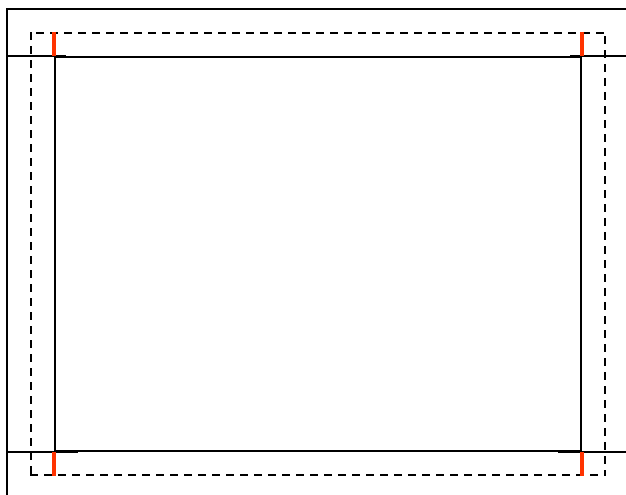

- Take the inside, long layer, and fold to the outside along dashed stitching line and cut 1/2" fringe. There will be a trip layer of fringe—the bottom layer which is part of the large rectangular piece of fleece, plus the folded over 2" strip.

- For each side corner—Fold, tuck under and top stitch down.

5. Cut 3/4" x 3/4" square out of corners.

